



TAIL TIDY

Installation Instructions

KTM DUKE

790 / 890 / 890R MODEL YEAR 2017+

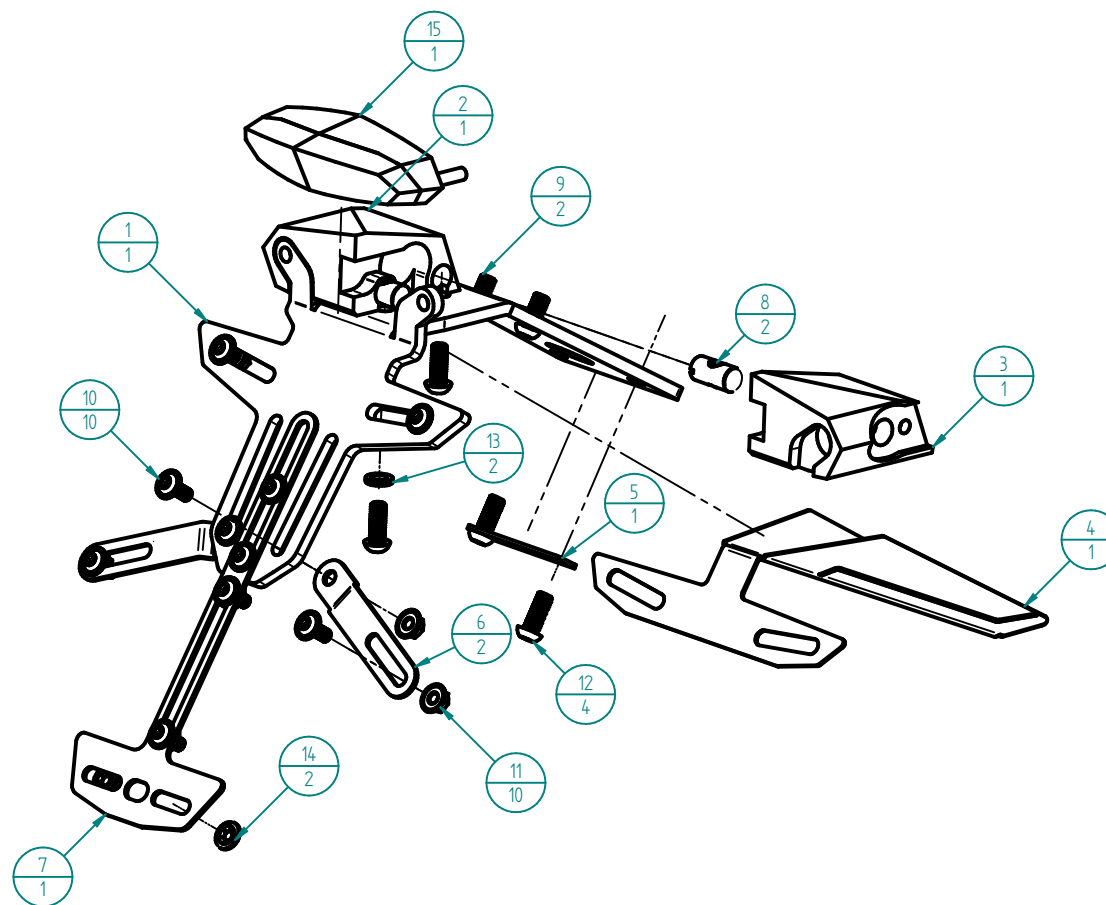

Item Number	Title	Quantity
1	Main Plate	1
2	Body Left	1
3	Body Right	1
4	Cover	1
5	Cover Holder	1
6	Licence Plate Extension - Long	2
7	Reflector holder	1

Item Number	Title	Quantity
8	Barrel Nut M6 F10x20	2
9	Bolt M6X14 A2 DIN/ ISO7380-1	2
10	Bolt M5X12 A2 DIN/ ISO7380-2	10
11	Nut M5 A2 DIN6923 ISO4161	10
12	Bolt M6X16 A2 DIN/ ISO7380-1	4
13	Washer A6 NL6 VZ NORD-LOCK	2
14	StarLock washer Stainless Steel 4MM	2
15	LED LIGHT DURA TAIL LIGHT 48V004BEQ-1	1

STEP 1

Put the cable of your signal light through the heat protector and part of the holder. Repeat the process with the other signal light.

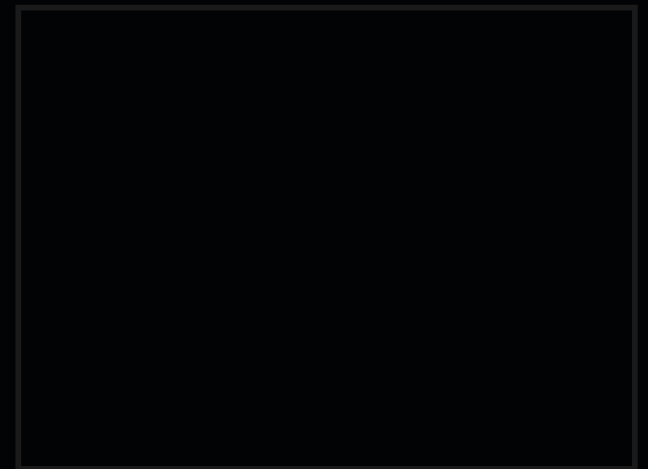
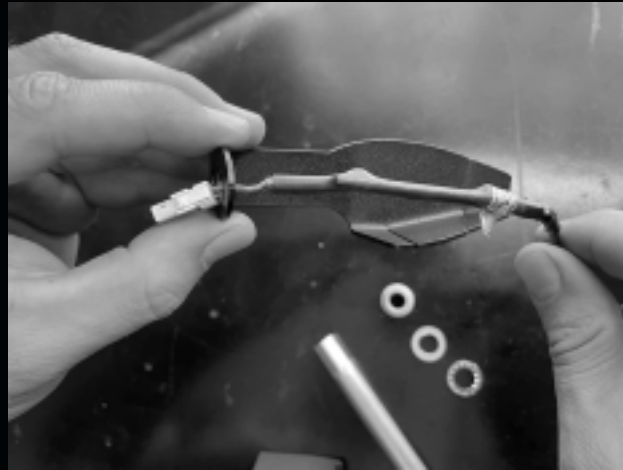

STEP 1.1

Take the original bolts and washer and set them as shown on picture. Take the screw and fully thighten them. You can use the original KTM spark plug wrench. Repeat the process with the other signal light.

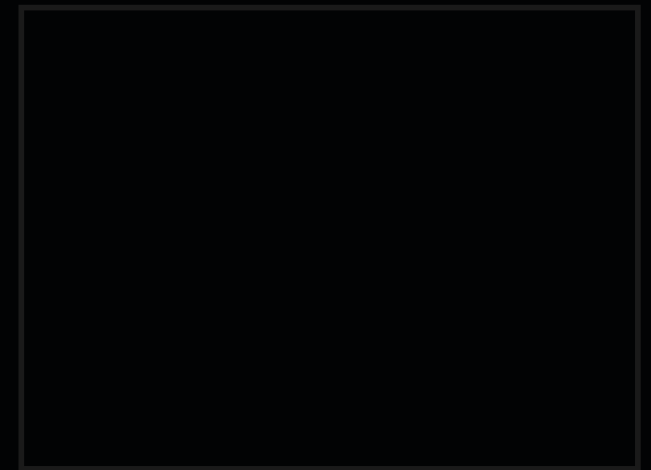
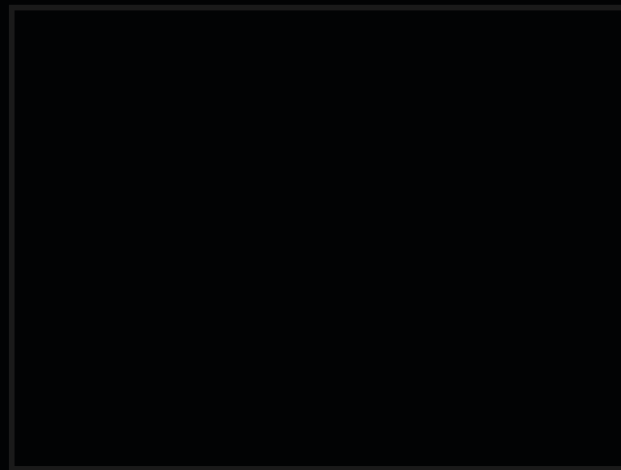
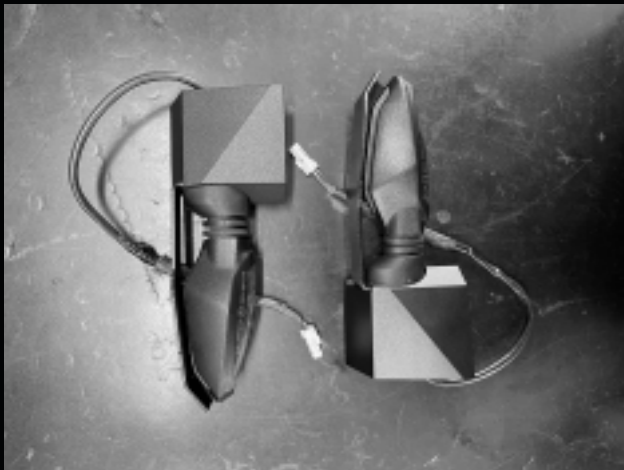
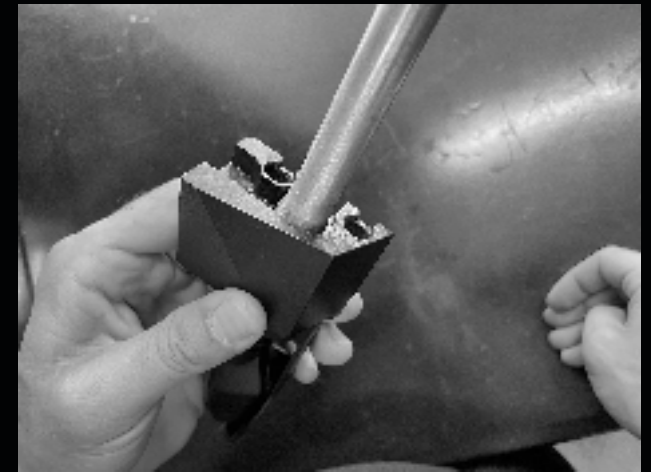
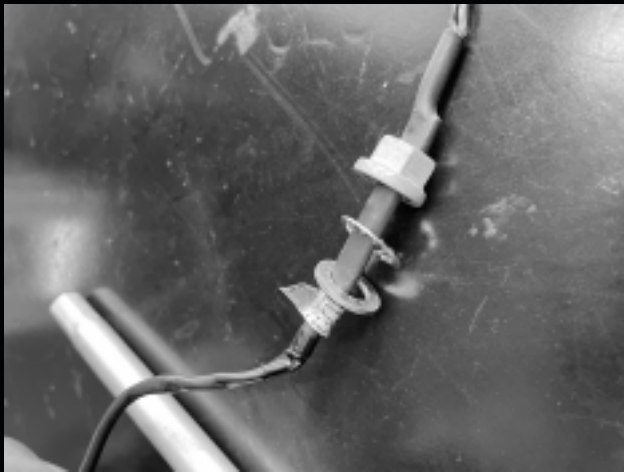

STEP 2

Let's place the light to the plate holder. Set the cable as shown in picture. When the cable is placed Set the light with original bolt and fully tighten.

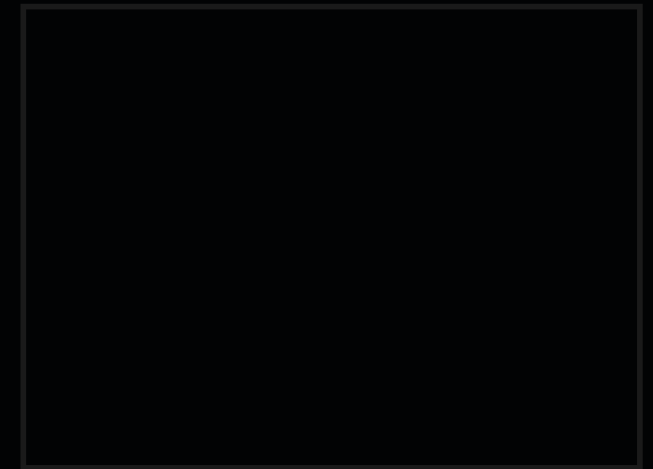
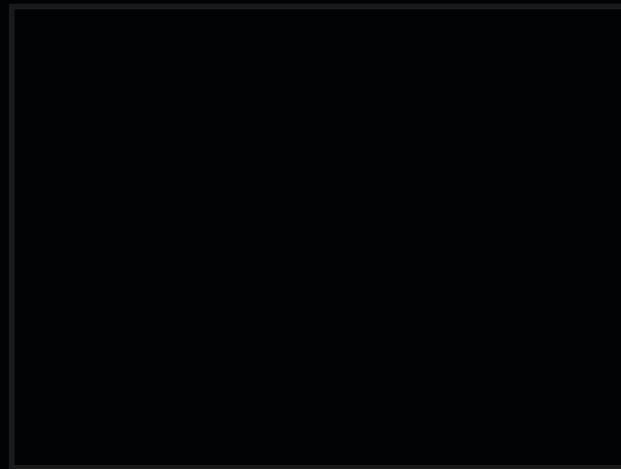
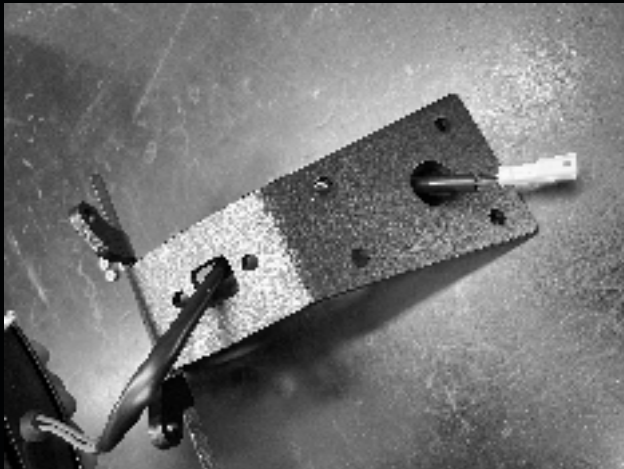
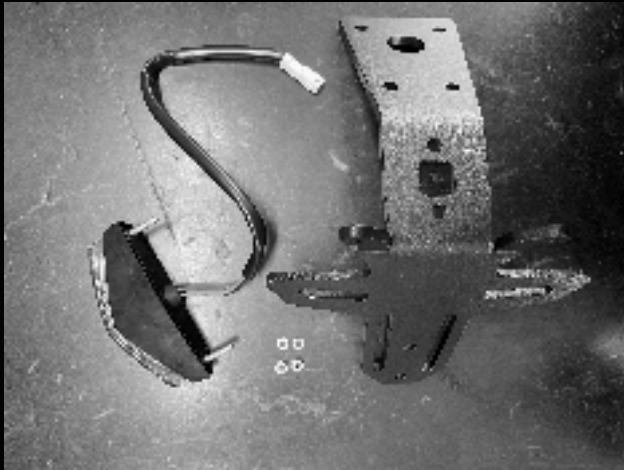

STEP 3

When light is fixed you will need to take the both composed parts from STEP 1.1. and join them with composed part from STEP 2. Let's begin.

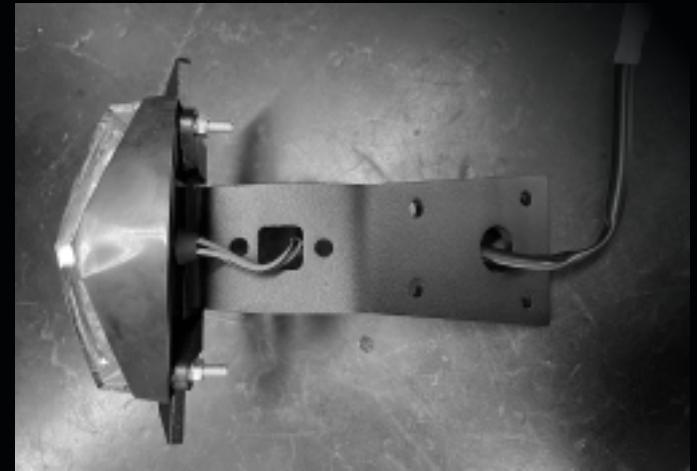

STEP 3.1

Take the barrel nut and place it in the side of the element. Do the same with other side. Put both cables from turn signals in the hole, same as you did in STEP 2.



STEP 3.2

When you've successfully finished that, put both mounted signal lights together

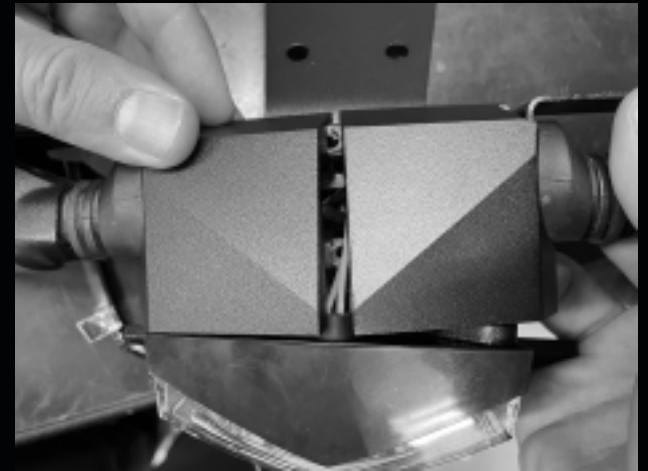
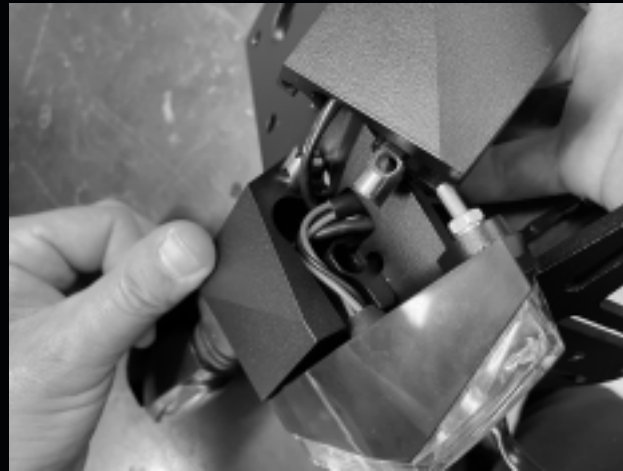
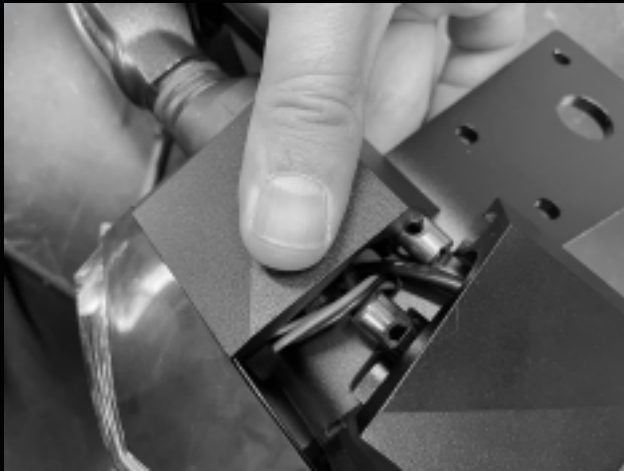

STEP 3.3

After you've placed both together, turn the whole element on the back side and screw 2x bolts with 2x washer.

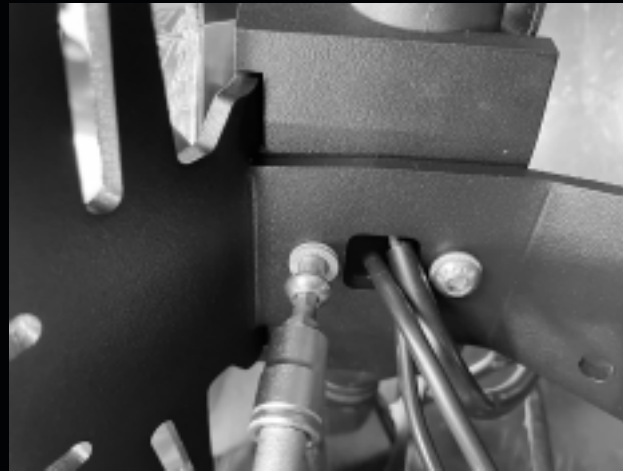
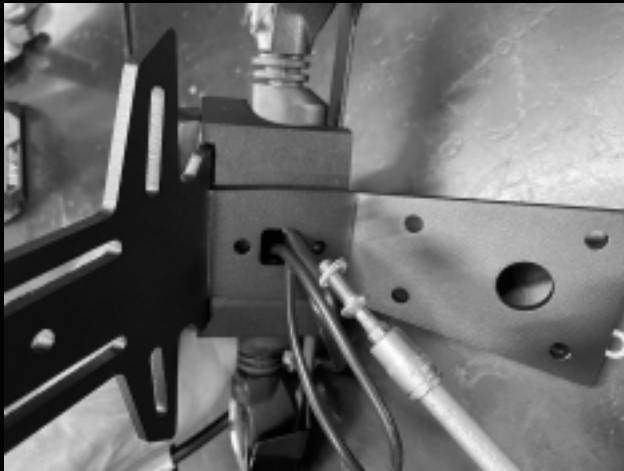

STEP 3.4

You are almost there. Put all cables (2x signal cables and light cable) through the big hole of plate holder.

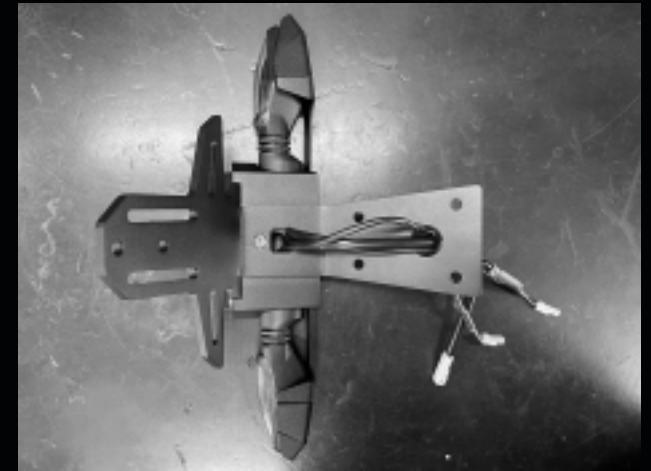
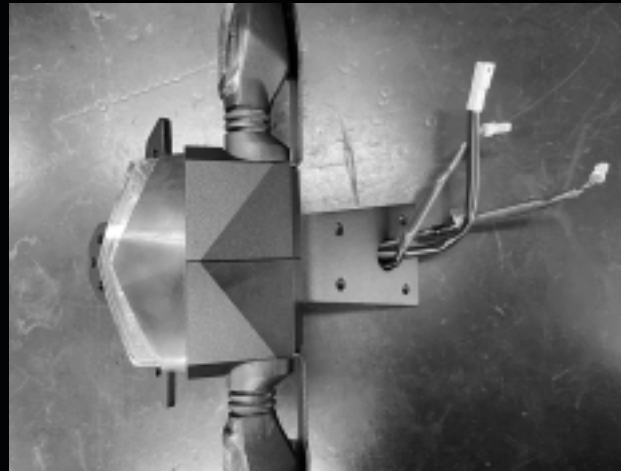
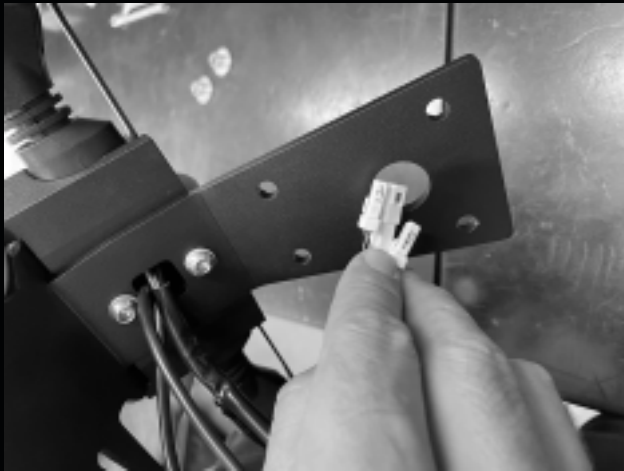

STEP 4

Mount the part to the finished element from STEP 3.5 with 4x bolts and 4x nuts.



STEP 4.1

Mount two plate extenders to the lower part of the Tail Tidy as seen in pictures with 4x bolts and 4x nuts.

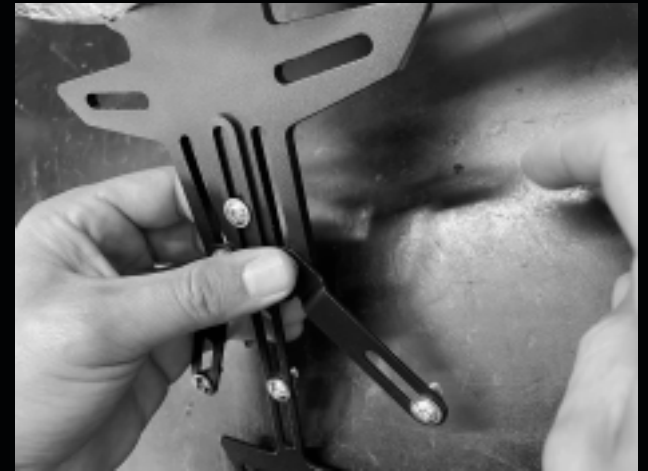

STEP 5

Almost DONE! :D Open the trunk of your bike and demount the original Tail Tidy of your bike.



STEP 6

Take the mounted Tail Tidy from STEP 5 and put the cables from lower part of your bike through your trunk.

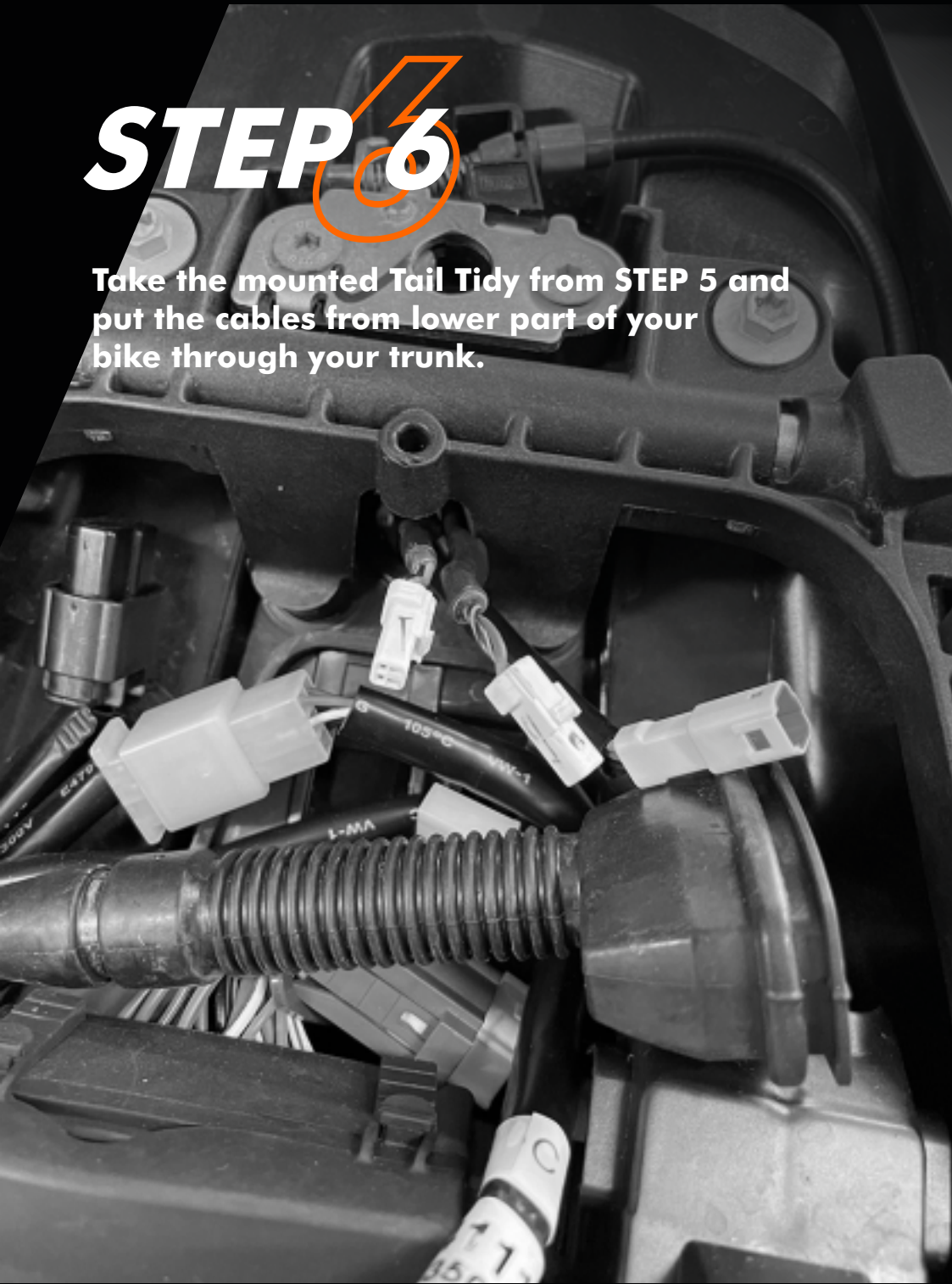

STEP 6.1

Mount the Tail tidy to your trunk with 2x bolts in the upper side.



STEP 6.2

Take the tile and place 2x bolts in the holes. Screw this set to lower part of the Tail Tiy to your bike – **NOTICE: Don't fully tighten and leave some space.**



STEP 7

We Promise, almost DONE! :D
Take the cover and place it under your Tail Tidy
and stuck it between the bolts and cover
holder from STEP 6.2.



STEP 7.1

Fully Tighten with bolts.



STEP 7.2

Screw together the cover and Main plate with 2x bolts and 2x nuts as seen in picture.



STEP 8

Mount the reflector to the Tail tidy with original bolts and caps from reflectors and washer.



USA *step*

Mount the additional tiles for US plate holders as shown in picture with bolts and caps.



IMPORTANT

It is recommended that periodic inspections are made to ensure that all bolts are tightened to the specified torque settings. Should the bike be involved in an accident a thorough inspection should be made and any components that have taken an impact, no matter how small, be replaced.

The manufacturer or supplier cannot be held responsible for products that are incorrectly mounted or inappropriately used.

It is recommended to check all connections regularly for tightness of fit.



www.bagorosperformance.com/product/tail-tidy-ktm-duke-790-890r/

A decorative graphic at the bottom right of the page consisting of several parallel, slanted grey bars of varying lengths, creating a sense of motion or a stylized signature.